

Finite Element Analysis to Investigate the Influence of Delamination Size, Stacking Sequence and Boundary Conditions on the Vibration Behavior of Composite Plate

M. Imran¹, R. Khan² and S. Badshah³

¹ Muhammad.imran@iiu.edu.pk

Received: April 2018 Revised: June 2018 Accepted: August 2018

Department of Mechanical Engineering, International Islamic University, Islamabad, Pakistan

DOI: 10.22068/ijmse.16.1.11

Abstract: Composite structures are widely used in many applications ranging from, but not limited to, aerospace industry, automotive, and marine structures due to their attractive mechanical properties like high strength to weight ratios. However composite structures needs utmost care during structures manufacturing and working conditions should be assessed prior to installation. One of the important defect in composite structures is delamination. Present work is focused on investigation of delamination defect on the natural frequencies of composite plate using commercial finite element software, ABAQUS. Analytical results were also analyzed using MATLAB code. Different stacking sequences and boundary conditions were considered for study in both analytical formulation and finite element analysis. Finite element results were compared with analytical results to validate the perfect composite plate. The natural frequency of the composite plate reduced with an increase in delamination size. Additionally, all-sides clamped composite plate showed higher values of natural frequency than other constraints in lower modes for symmetrical laminates. Natural frequency in cross ply laminates was higher for the simply supported composite plates. On comparison, results from both the techniques, finite element analysis and analytical analysis, were in good agreement.

Keywords: Composite material, Delamination, Finite element analysis, ABAQUS simulation, Natural frequency

1. INTRODUCTION

The application of composites in various fields of sporting equipment, aerospace, marine and agricultural products have increased tremendously due to their multi-dimensional, attractive and novel properties [1-3] along with low maintenance of composite materials [4]. Composite materials have many advantages when compared to conventional materials [5]. They are lightweight, cheaper, stiffer, stronger and eco-resistant [6, 7].

Zhu et al [8] conducted finite element analysis to find the free vibration properties of carbon nano tube reinforced composite plate and compared the results with ANSYS software package. Fantuzzi et al [9] compared the analytical results with finite element methods results for vibration properties of functionally graded carbon nano tube reinforced plate.

Shu et al [10] conducted vibration analysis of composite beams. Structure was incorporated with two delamination (non-overlapping). Rout et

al [11] conducted finite element analysis to find the impact of delamination, fiber orientation and twist angle on the vibration characteristics of pre-twisted laminated cylindrical shells. Thornburgh et al [12, 13] analyzed vibration characteristics of delaminated composite laminates using finite elements. They used third order shear deformation theory. Sahoo et al [14] conducted finite element method analysis using MATLAB code. Ganesh et al [15] conducted vibration analysis using first order shear deformation theory and computational methods to analyze vibration characteristics of delaminated composite plate.

Nagesh et al [16] did finite element analysis to find the effect of delamination on the natural frequencies. Shankar et al [17] developed MATLAB code to find the vibration properties of delaminated composite plate. Amit et al [18] conducted vibration analysis to find the effect of crack length on natural frequencies of graphite epoxy composite pre-twisted shells using finite element method. Hu et al [19] used delaminated composite beam and plate to find the effect of

delamination using finite element based higher order shear deformation theory. Saravanos and Hopkins [20] investigated the delaminated laminates and beams using generalized laminate theory.

Ju et al [21] did an investigation on the delaminated composite plate using finite element method with 8-node, 40 degree of freedom isoparametric plate element and Mindlin theory was used for analytical solution. Shen et al [22] conducted vibration analysis to find the effect of delamination on composite beam subjected to delamination. They used Timoshenko Beam Theory and local Rayleigh Ritz Method. Fundamental resonant frequencies showed declining trend by the increase of delamination sizes. Ju et al [23] investigated effect of multiple delamination. They used composite beam and first order shear deformation Timoshenko Beam Theory. They concluded that the impact of first three delamination in lower modes is about uniform however it has significant effect for higher modes.

Kitipornchai et al [24] find the effect of crack depth on functionally graded materials cracked beam using Ritz Method. Crack depth has no significance influence of non-linear frequencies however linear frequencies are greatly reduced and the both linear and non-linear frequencies are more sensitive for cracks at mid span.

Qu et al [25] investigated Piezoelectric composite plate with cracks using classical laminated theory. Systematic reduced values of natural frequencies of composite plate would happen in the presence of cracks however this decrease of natural frequencies is in small amounts.

Chang et al [26] find the influence of delamination size on delaminated composite plate subjected to axial load using classical plate theory. It was concluded that as the delamination size increases, fundamental natural frequency value gets smaller. This behavior was also predicted by [27-29].

Talookolaei et al [30] did an investigation on composite beam with single delamination using Hamilton's principle. They concluded that an increase in delamination length significantly reduced the natural frequencies. Natural

frequencies increased with an increase in the rotating speed.

Kulkarni and Frederick [31] investigated the clamped circular cylindrical shell with circumferential central crack using linear thin shell theory and Kirchhoff-Love's theorem. The delamination region was considered as reduced bending stiffness. No any specific conclusion was provided inspite of the well-written theory. Thuc et al [32] carried out free vibration analysis using ANSYS and ABAQUS and compared results with numerical ones obtained from shear and normal deformation theory on the axial loaded composite beam. Arthur et al [33] conducted free vibration analysis and find the dynamic response of bio-based composite beam using experimental and finite element analysis software packages.

The review, of the above works, shows that finite element work, using finite element software packages like ANSYS or ABAQUS, is very rare and literature already done have not much concentrated on the delamination influence on the vibration characteristics of the carbon fiber reinforced polymer composite rectangular plate using these methods. The literature, having finite element analysis using these tools to find the natural frequencies for carbon fiber reinforced polymer is very poor. Keeping in view the above work, present study is focused on free vibration of carbon reinforced polymers delaminated composite plate by using finite element software packages and by using analytical technique to find the natural frequencies. The influences of delamination size, ply orientation and boundary conditions on natural frequencies of carbon fiber reinforced polymer are studied extensively.

2. ANALYTICAL APPROACH

The differential equation for the transverse bending of a plate having rectangular orthotropic plate is depicted in equation (1)

$$D_x \frac{\partial^4 \omega}{\partial x^4} + 2D_{xy} \frac{\partial^4 \omega}{\partial x^2 \partial y^2} + D_y \frac{\partial^4 \omega}{\partial y^4} + \rho \frac{\partial^2 \omega}{\partial t^2} = 0 \quad (1)$$

where D_x , D_y , D_{xy} are the stiffness terms computed for homogenous plate. Because they are computed for such a plate, we must

change them with the terms which describe a laminate composite plate. Replacing α_{11} , α_{12} and α_{13} with D_{11} , D_{12} and D_{13} respectively, we can write, as

$$D_{11} = \alpha_{11} \quad (2)$$

$$D_{12} = \alpha_{12} \quad (3)$$

$$D_{13} = \alpha_{13} \quad (4)$$

The terms D_{11} , D_{12} , and D_{66} are computed using the equations presented below.

$$D_{11} = \frac{E_x h^3}{12(1-\nu_{xy}\nu_{yx})} \quad (5)$$

$$D_{12} = D_{21} = \frac{\nu_{yx} E_x h^3}{12(1-\nu_{xy}\nu_{yx})} = \frac{\nu_{xy} E_y h^3}{12(1-\nu_{xy}\nu_{yx})} \quad (6)$$

$$D_{22} = \frac{E_y h^3}{12(1-\nu_{xy}\nu_{yx})} \quad (7)$$

$$D_{66} = \frac{G_{xy} h^3}{6} \quad (8)$$

The moment curvature relations are used for governing equations;

$$M_x = -D_x \left(\frac{\partial^2 \omega}{\partial x^2} + \nu_y \frac{\partial^2 \omega}{\partial y^2} \right) \quad (9)$$

$$M_y = -D_y \left(\frac{\partial^2 \omega}{\partial y^2} + \nu_x \frac{\partial^2 \omega}{\partial x^2} \right) \quad (10)$$

$$M_{xy} = -2D_{xy} \frac{\partial^2 \omega}{\partial x \partial y} \quad (11)$$

From the above equations, Rayleigh Ritz method [34-37] is used to find the frequencies as in equation (12)

$$\omega^2 = \frac{1}{\rho} \left(\frac{A^4 D_x}{a^4} + \frac{B^4 D_y}{b^4} + \frac{2CD_{xy}}{a^2 b^2} \right) \quad (12)$$

Where A, B, C and D are frequency coefficients and they depend upon the boundary conditions applied and are determined from the equations (13, 14) in case of simply supported plate.

$$A = \gamma_0 \quad (13)$$

$$B = \epsilon_0 \quad (14)$$

After putting the value of all sides clamped boundary conditions in the equation (15), we will

solve this in Matlab tool to fetch frequencies.

$$\omega_{m,n} = \frac{\pi^2}{a^2 \sqrt{\rho}} \sqrt{D_x m^4 + 2D_{x,y} m^2 n^2 \left(\frac{a}{b}\right)^2 + D_y n^4 \left(\frac{a}{b}\right)^4} \quad (15)$$

where, a, b and ρ are width, height and density of the plate respectively.

Following equations are used to find the values of constants.

$$\gamma_1 = \left(m + \frac{1}{4}\right) \pi \quad (16)$$

$$\gamma_2 = \left(m + \frac{1}{2}\right) \pi \quad (17)$$

$$\epsilon_1 = \left(n + \frac{1}{4}\right) \pi \quad (18)$$

$$\epsilon_2 = \left(n + \frac{1}{2}\right) \pi \quad (19)$$

Next, using the MATLAB file provided, we will compute the values of D_{11} , D_{12} , and D_{66} . For the case considered, the values for D_{11} , D_{12} , and D_{66} are:

$$D_{11} = 4.35e+04 \text{ N/mm}^2$$

$$D_{12} = 8.34e+03 \text{ N/mm}^2$$

$$D_{66} = 6.96e+03 \text{ N/mm}^2$$

At this point, we have all the data necessary to compute the first natural frequency for the CCCC, no delamination, (0/90) plate. Substituting the values for D_{11} , D_{12} , and D_{66} , A, B and C into equation (15) we get: $\omega_1 = 5571.89 \text{ rad/s}$, from this we can compute the natural frequency from equation (15) and get $f_1 = 886.8 \text{ Hz}$. All natural frequencies are computed for 12 modes using MATLAB tool.

3. FINITE ELEMENT ANALYSIS USING ABAQUS

Pre-processing was done in Ansa V_16.2.3, Processing in ABAQUS V13 and Post-processing in meta V_16.2.3. All delamination surfaces are located in the middle-plane of the composite laminated plate as shown in Fig. 1.

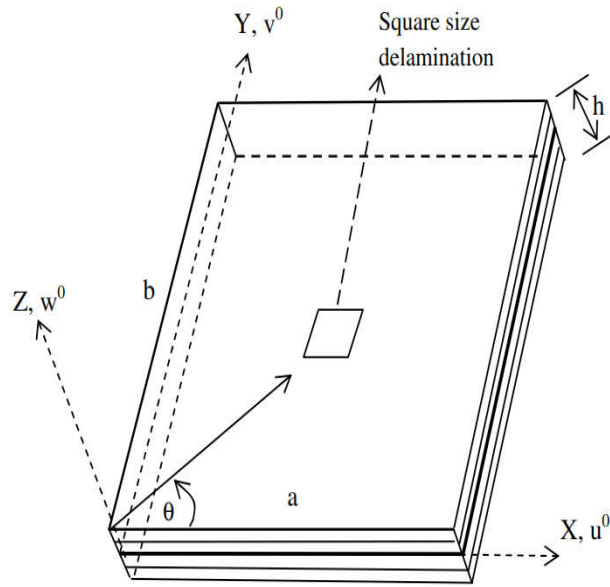

Fig. 1. Schematic diagram of delamination location.

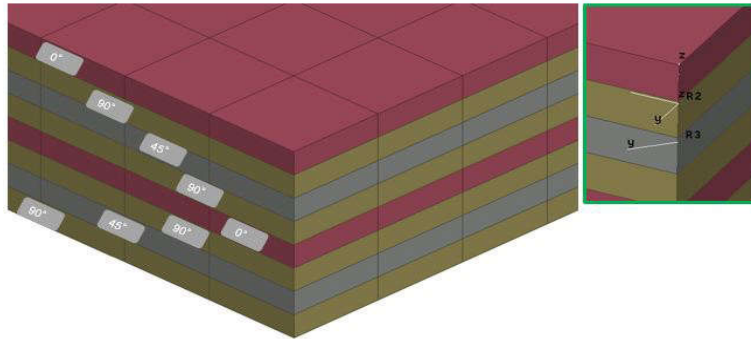

Fig. 2. R2 is rotated 90° around z global axis and R3 is rotated 45° around z global axis.



Fig. 3. Top view of delamination incorporated.

The orientation of the layers has been made using coordinate systems as shown in Fig. 2.

The delamination effect was modeled as a disconnected area between the two adjacent mid plane layers as shown in Fig. 3.

A total of 48 models each consisting in at least 12 natural frequencies and their corresponding modal shapes were computed.

4. COMPARISON OF FINITE ELEMENT AND ANALYTICAL RESULTS

For this comparison, all-sides clamped and all sides simply supported are considered. The no delaminated plates with all stacking sequences are considered. The results listed in Table 1 show that the analytical results and the Finite element results are in better agreement for both type of boundary conditions.

The relative error between the 2 results shows an increase with the mode's frequency but does not exceed 6% (regardless of the stacking type or boundary condition). It is possible to conclude that the analytical method, in the absence of experimental results, can be used to validate the FEA model.

As of boundary condition, the SSSS model is correlated better with the analytically results (biggest relative error -3%).

4.1. Effect of Delamination Area

In the present study, 3 mid-plane delamination areas were considered: 6.25%, 25% and 56.25%. For a (0/45/90/0)₂ plate, all edges free, the fundamental frequency as a function of delaminated size is presented in the Fig. 4.

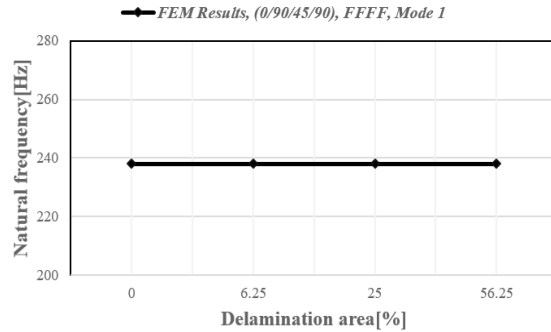

Fig. 4. First natural frequency versus delamination area of all edges free composite plate.

Table 1. Comparison of natural frequencies for finite element and analytical analysis subjected to different boundary conditions.

Boundary condition	Stacking	Method	Model 1 , Hz	Mode2 , Hz	Mode3 , Hz	Mode4 , Hz
CCCC	0/90/45/90	FEA	883.41	1804.1	1804.1	2538
		Analytical	886.79	1822.9	1822.9	2522.2
		Error,%	0.4	1.0	1.0	-0.6
	0/45	FEA	876.31	1776.6	1776.6	2601.4
		Analytical	882.41	1802	1802	2659.03
		Error,%	0.7	1.4	1.4	2.2
	0/90	FEA	887.42	1820	1820	2489.8
		Analytical	886.79	1837.03	1837.03	2522.2
		Error,%	0.1	0.9	0.9	1.3
SSSS	0/90/45/90	FEA	444.78	1175.8	1175.8	1769.6
		Analytical	447.64	1182.3	1182.3	1790.6
		Error,%	0.6	0.5	0.5	1.2
	0/45	FEA	475.96	1191.9	1191.9	1892.9
		Analytical	482.41	1206.02	1206.02	1929.6
		Error,%	1.3	1.2	1.2	1.9
	0/90	FEA	421.66	1163.1	1163.1	1678.2
		Analytical	422.20	1165.8	1165.8	1688.8
		Error,%	0.1	0.2	0.2	0.6

The fundamental frequency for the 6.25%, 25% and 56.25% are found to remain constant, compared with the no delamination plate, for the FFFF, (0/45/90/0)₂ plate. The same conclusion can be extended for the first 3 modes of the FFFF plates, regardless of the stacking sequence. As shown in Fig. 5, the delamination area's influence has a maximum in the case of mode 12, where the frequency is decreasing by 0.01%, 0.1 % and 0.3 % (for the 6.25%, 25% and 56.25% delaminated plates).

The same comparison was carried out on the composite plate with cantilever boundary conditions and all-sided clamped. The first natural frequency of the (0/90)₄ is presented subjected to delamination size in Fig. 6.

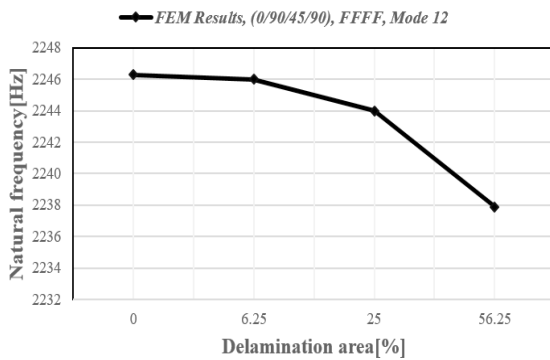
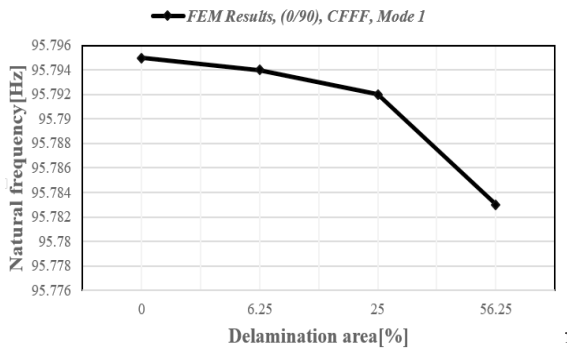

Fig. 5. Trends of 12th natural frequency subjected to variation in delamination area of all edges free composite plate



in delamination area of one side clamped composite plate

In this case (the CFFF, (0/90)₄ composite plate), the major decrease (0.012%) is found for the plate with the 56.25% delamination area.

Considering the plate with all the edges clamped, (0/45)₄, the first natural frequency, as a function of delamination area, is presented in Fig. 6.

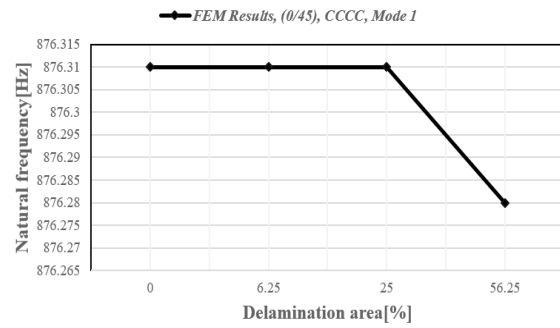

Fig. 7. Trends of 1st natural frequency subjected to variation in delamination area of all sides clamped composite plate

With an increase of the delaminated area, independently of the boundary condition or stacking order, the first natural frequency decreases. So, if we would to manufacture a composite plate with number of delamination areas (randomly distributed between the layers), the first frequency at which the plate would vibrate would decrease. Also, if the delamination areas are small (compared to the overall dimensions of the plate), there is no influence on the first natural frequency of the composite plate as shown in Fig. 7.

4.2. Effect of Boundary Conditions

For this investigation, 4 types of boundary conditions are considered:

- CCCC (all edges clamped)
- SSSS (all edges simply supported)
- CFFF (cantilever plate) and
- SSSS (all edges simply supported)

The 12 natural frequencies for delamination of 6.25%, 25% and 56.25% are shown in Table 2, Table 3 and Table 4. The smallest natural frequencies refer to CFFF (one edge clamped) condition and the highest ones refer to CCCC (all sides clamped) boundary condition. Considering the first natural frequency of the plate with a 56.25% delaminated area, applying a SSSS and CFFF boundary condition will decrease the eigenvalue by 45.68%, 64.7% and 90.34% (compared to the all-side clamped composite plate). The same conclusions can be extended to the other stacking sequences considered in this study.

Table 2. Comparison of natural frequencies for 6.25% delaminated plate for various boundary conditions

Boundary condition	CCCC	SSSS	FFFF	CFFF
Mode 1 , Hz	876.31	475.96	309.18	84.583
Mode2 , Hz	1776.4	1191.7	463.92	198.07
Mode3 , Hz	1776.4	1191.7	599.98	511.18
Mode4 , Hz	2601.4	1892.9	811.36	655.37
Mode5 , Hz	3161.1	2381.4	811.36	727.74
Mode6 , Hz	3177.6	2381.8	1482.3	1273.1
Mode7 , Hz	3936.6	3065	1482.3	1483.5
Mode8 , Hz	3936.6	3065	1485.1	1531.4
Mode9 , Hz	5010.2	4029	1617.3	1698.5
Mode10 , Hz	5010.2	4029	1852	2196.1
Mode11 , Hz	5210.7	4216.7	2461.4	2280.7
Mode12 , Hz	5723.9	4694	2461.4	2853.6

Table 3. Comparison of natural frequencies for 25% delaminated plate for various boundary conditions

Boundary condition	CCCC	SSSS	FFFF	CFFF
Mode 1 , Hz	876.31	475.96	309.18	84.581
Mode2 , Hz	1774.5	1191	463.92	198.07
Mode3 , Hz	1774.5	1191	599.98	511.18
Mode4 , Hz	2601.3	1892.8	811.31	655.36
Mode5 , Hz	3160.9	2381.3	811.31	727.69
Mode6 , Hz	3177.3	2381.7	1481.6	1273.1
Mode7 , Hz	3933.5	3063.3	1481.6	1482.8
Mode8 , Hz	3933.5	3063.3	1485.1	1531
Mode9 , Hz	4995	4020	1617.3	1698.2
Mode10 , Hz	4995	4020	1852	2194.6
Mode11 , Hz	5210.1	4216.5	2459.4	2279
Mode12 , Hz	5723.9	4694	2459.4	2853.6

As the natural frequencies are very sensitive to the boundary condition type applied, the most advantageous way of constraining a composite plate with delamination is by clamping all the sides.

5. EFFECT OF STACKING SEQUENCE

In order to show the effect of the stacking sequence on the natural frequencies, the 6.25%, 25% and 56.25% delaminated plates, one side clamped, all stacking sequences, composite plates

Table 4. Comparison of natural frequencies for 56.25% delaminated plate for various boundary conditions

Boundary condition	CCCC	SSSS	FFFF	CFFF
Mode 1 , Hz	876.28	475.95	309.18	84.575
Mode2 , Hz	1768.7	1188.7	463.92	198.07
Mode3 , Hz	1768.7	1188.7	599.97	511.18
Mode4 , Hz	2600.8	1892.7	811.15	655.31
Mode5 , Hz	3159.8	2380.9	811.15	727.54
Mode6 , Hz	3175.5	2381	1479.2	1272.9
Mode7 , Hz	3923.7	3057.7	1479.2	1480.6
Mode8 , Hz	3923.7	3057.7	1485	1529.6
Mode9 , Hz	4950.5	3993.3	1617.3	1697.3
Mode10 , Hz	4950.5	3993.3	1851.8	2189.8
Mode11 , Hz	5206.5	4214.7	2453.3	2273.6
Mode12 , Hz	5723.9	4691.6	2453.3	2853.1

Table 5. The natural frequency for a 6.25% delaminated plate with various stacking sequences

Stacking	0/90/45/90	0/45	0/90
Mode1 , Hz	91.647	84.583	95.794
Mode2 , Hz	168.4	198.07	140.23
Mode3 , Hz	564.2	511.18	594.62
Mode4 , Hz	654.7	655.37	649.57
Mode5 , Hz	691.05	727.74	658.57
Mode6 , Hz	1142.4	1273.1	1027.7
Mode7 , Hz	1596.2	1483.5	1665.2
Mode8 , Hz	1628	1531.4	1682.8
Mode9 , Hz	1722	1698.5	1730.8
Mode10 , Hz	2074.3	2196.1	1970.4
Mode11 , Hz	2120.5	2280.7	1988.9
Mode12 , Hz	2965.4	2853.6	2603.6

Table 6. The natural frequency for a 25% delaminated plate with various stacking sequences

Stacking	0/90/45/90	0/45	0/90
Mode1 , Hz	91.645	84.581	95.792
Mode2 , Hz	168.4	198.07	140.23
Mode3 , Hz	564.2	511.18	594.61
Mode4 , Hz	654.69	655.36	649.57
Mode5 , Hz	691.03	727.69	658.56
Mode6 , Hz	1142.4	1273.1	1027.7
Mode7 , Hz	1595.5	1482.8	1664.2
Mode8 , Hz	1627.6	1531	1682.3
Mode9 , Hz	1721.7	1698.2	1730.5
Mode10 , Hz	2072.6	2194.6	1968.4
Mode11 , Hz	2118.7	2279	1987.2
Mode12 , Hz	2965.2	2853.6	2603.6

Table 7. The natural frequency for a 56.25% delaminated plate with various stacking sequences

Stacking	0/90/45/90	0/45	0/90
Mode1 , Hz	91.638	84.575	95.783
Mode2 , Hz	168.4	198.07	140.23
Mode3 , Hz	564.2	511.18	594.61
Mode4 , Hz	654.65	655.31	649.55
Mode5 , Hz	690.96	727.54	658.54
Mode6 , Hz	1142.3	1272.9	1027.6
Mode7 , Hz	1593.1	1480.6	1661.2
Mode8 , Hz	1626	1529.6	1680.7
Mode9 , Hz	1720.8	1697.3	1729.3
Mode10 , Hz	2067.3	2189.8	1962.4
Mode11 , Hz	2113.3	2273.6	1981.8
Mode12 , Hz	2964	2853.1	2603.6

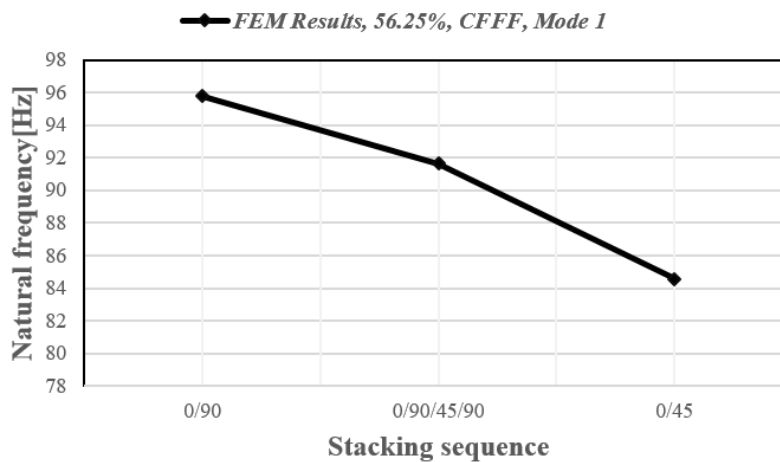
**Fig. 8.** Trends of natural frequency for different stacking sequences subjected to cantilever composite plate with delamination

are presented in Table 5, Table 6 and Table 7. The results corresponding to the first mode from Table 5 are represented in Fig. 8.

From Fig. 8, it can be concluded that the most advantageous stacking sequence, in the case of a delaminated composite plate, is (0/90)4. Also, the stacking sequence does not influence the first modal shape but it has an effect on the amplitude of the vibration. The same conclusions can be extended to the other boundary condition composite plates.

6. CONCLUSION

In this study, a delaminated composite plate

was analyzed using a finite element model. Carbon fiber reinforced polymer composite plate's models without delamination were investigated analytically. The effect of the delamination area, boundary conditions and stacking orientation were analyzed. The existence of delamination areas between the layers of a composite plate determines the decrease of the natural frequencies. The small differences are due to the small delamination areas. Good correlation was observed for the results of analytical and finite element analysis. Considering the same delamination area but different boundary conditions, one may conclude that the eigenvalues depend also on the boundary conditions also. If delamination areas are present between the layers of the

composite plate, the best way of constraining it is by clamping all edges. Considering a cantilever composite plate, the highest natural frequency is obtained for the (0/90) stacking sequence. The stacking sequence influences the amplitude of the vibration but has no effect on the modal shapes.

REFERENCES

1. Kamar, N. T., Drzal, L. T., Lee, A., Askeland, P. "Nanoscale toughening of carbon fiber reinforced/ epoxy polymer composites (CFRPs) using a triblock copolymer." *Polymer*, 2017, 111, 36-47.
2. Jiang, Z., Wen, H. and Ren, S., "Modeling delamination of FRP laminates under low velocity impact" *IOP Conference Series: Materials Science and Engineering: IOP Publishing*, 2017, 42, 012088
3. Aksencer, T., Aydogdu, M., "Vibration of a rotating composite beam with an attached point mass". *Composite Structures*, 2018, 190, 1-9.
4. Asmatulu, E., Alonayni, A., Alamir, M. and Rahman, M. M., "Sustainability of fiber reinforced laminate and honeycomb composites in manufacturing industries" *Behavior and Mechanics of Multifunctional Materials and Composites XII: International Society for Optics and Photonics*; 2018, 1059624.
5. Karsh, P. K., Mukhopadhyay, T., Dey, S., "Spatial vulnerability analysis for the first ply failure strength of composite laminates including effect of delamination." *Composite Structures*, 2018, 184, 554-567.
6. Bakis, C., Bank, L. C., Brown, V., Cosenza, E., Davalos, J., Lesko, J., Machida, A., Rizkalla, S. H. and Triantafillou, T. C., "Fiber-reinforced polymer composites for construction-state-of-the-art review." *Journal of composites for construction*, 2002, 6, 73-87.
7. Kumar, N., Mireja, S., Khandelwal, V., Arun, B., Manik, G., "Light-weight high-strength hollow glass microspheres and bamboo fiber based hybrid polypropylene composite: A strength analysis and morphological study". *Composites Part B: Engineering*, 2017, 109, 277-285.
8. Zhu, P., Lei, Z. X. and Liew, K. M., "Static and free vibration analyses of carbon nanotube-reinforced composite plates using finite element method with first order shear deformation plate theory." *Composite Structures*, 2012, 94, 1450-1460.
9. Fantuzzi, N., Tornabene, F., Baccocchi, M. and Dimitri, R., "Free vibration analysis of arbitrarily shaped Functionally Graded Carbon Nanotube-reinforced plates." *Composites Part B: Engineering*, 2017, 115, 384-408.
10. Shu, D. and Della, C. N., "Free vibration analysis of composite beams with two non-overlapping delaminations." *International Journal of Mechanical Sciences*, 2004, 46, 509-526.
11. Rout, M., Hota, S. S. and Karmakar, A., "Free vibration characteristics of delaminated composite pretwisted stiffened cylindrical shell. Proceedings of the Institution of Mechanical Engineers," Part C: *Journal of Mechanical Engineering Science*, 2018, 232 (4), 595-611.
12. Thornburgh, R. and Chattopadhyay, A., "Combined delamination and matrix cracking in adaptive composite laminates". 44th AIAA/ASME/ASCE/AHS/ASC Structures, Structural Dynamics, and Materials Conference, Norfolk, Virginia, 2003, 1-11.
13. Thornburgh, R. and Chattopadhyay, A., "Unified approach to modeling matrix cracking and delamination in laminated composite structures." *AIAA journal*, 2001, 39, 153-160.
14. Sahoo, S.S., Panda and S. K., Sen, D., "Effect of Delamination on Static and Dynamic Behavior of Laminated Composite Plate". *AIAA Journal*, 2016, 2530-2544.
15. Ganesh, S., Kumar, K. S. and Mahato, P. K., "Free Vibration Analysis of Delaminated Composite Plates Using Finite Element Method." *Procedia Engineering*, 2016, 144, 1067-1075.
16. Hanagud, S. "Delaminations in smart composite structures-A parametric study on vibrations". In: 31st Structures, Structural Dynamics and Materials Conference, Long Beach (CA) U.S.A, 1990, 2417-2426.
17. Shankar, G., Keshava, Kumar, S. and Mahato, P. K., "Vibration analysis and control of smart composite plates with delamination and under hygrothermal environment." *Thin-Walled Structures*, 2017, 116, 53-68.
18. Karmakar, A., Roy, H., Kishimoto, K., "Free vibration analysis of delaminated composite pretwisted shells." *Aircraft Engineering and Aerospace Technology*, 2005, 77, 486-490.
19. Hu, N., Fukunaga, H., Kameyama, M., Aramaki, Y., Chang, F. K., "Vibration analysis of delaminated composite beams and plates using a higher-order finite element." *International Journal of Mechanical Sciences*, 2002, 44, 1479-1503.
20. Saravanos, D. A., Hopkins, D. A., "Effects of Delaminations on the Damped Dynamic Characteristics of Composite Laminates: Analysis

- And Experiments”. *Journal of Sound and Vibration*, 1996, 192, 977-993.
21. Ju, F., Lee, H. and Lee, K., “Finite element analysis of free vibration of delaminated composite plates.” *Composites engineering*, 1995, 5, 195-209.
 22. Shen, M. H. and Grady, J., “Free vibrations of delaminated beams.” *AIAA journal*, 1992, 30, 1361-1370.
 23. Ju, F., Lee, H. and Lee, K., “Free-vibration analysis of composite beams with multiple delaminations.” *Composites Engineering*, 1994, 4, 715-730.
 24. Kitipornchai, S., Ke, L. L., Yang, J., Xiang, Y., “Nonlinear vibration of edge cracked functionally graded Timoshenko beams.” *Journal of Sound and Vibration*, 2009, 324, 962-982.
 25. Qu, G. M., Li, Y. Y., Cheng, L., Wang, B., “Vibration analysis of a piezoelectric composite plate with cracks.” *Composite Structures*, 2006, 72, 111-118.
 26. Chang, T. P., Hu, C. Y., Jane, K. C., “Vibration Analysis of Delaminated Composite Plates Under Axial Load.” *Journal of Structural Mechanics*, 1998, 26, 195-218.
 27. Tenek, L. H., Henneke, E. G., Gunzburger, M. D., “Vibration of delaminated composite plates and some applications to non-destructive testing.” *Composite Structures*, 1993, 23, 253-262.
 28. Lee, J., “Free vibration analysis of delaminated composite beams.” *Computers & Structures*, 2000, 74, 121-129.
 29. Wang, J., Lin, C. C., “Vibration of beam-plates having multiple delaminations”. In: *36th Structures, Structural Dynamics and Materials Conference*, New Orleans (LA), U.S.A, 1995, 3126-3133.
 30. Jafari-Talookolaei, R. A., “Analytical solution for the free vibration characteristics of the rotating composite beams with a delamination.” *Aerospace Science and Technology*, 2015, 45, 346-358.
 31. Kulkarni, S. V., Frederick, D., “Frequency as a parameter in delamination problems—a preliminary investigation.” *Journal of composite materials*, 1971, 5, 112-117.
 32. Vo, T. P., Thai, H. T., Aydogdu, M., “Free vibration of axially loaded composite beams using a four-unknown shear and normal deformation theory.” *Composite Structures*, 2017, 178, 406-414.
 33. Monti, A., El, Mahi, A., Jendli, Z., Guillaumat, L., “Experimental and finite elements analysis of the vibration behaviour of a bio-based composite sandwich beam.” *Composites Part B: Engineering*, 2017, 110, 466-475.
 34. Vescovini, R., Dozio, L., D’Ottavio, M., Polit, O., “On the application of the Ritz method to free vibration and buckling analysis of highly anisotropic plates.” *Composite Structures*, 2018, 192, 460-474.
 35. Oliveri, V., Milazzo, A., “A Rayleigh-Ritz approach for postbuckling analysis of variable angle tow composite stiffened panels.” *Computers & Structures*, 2018, 196, 263-276.
 36. Sayyad, A. S. and Ghugal, Y. M., “Bending, buckling and free vibration of laminated composite and sandwich beams: A critical review of literature.” *Composite Structures*, 2017, 171, 486-504.
 37. Ardestani, M. M., Zhang, L., Liew, K., “Isogeometric analysis of the effect of CNT orientation on the static and vibration behaviors of CNT-reinforced skew composite plates”. *Computer Methods in Applied Mechanics and Engineering*, 2017, 317, 341-379.